

BRACCIOLO | ACCOUDOIR | ARM

MIA

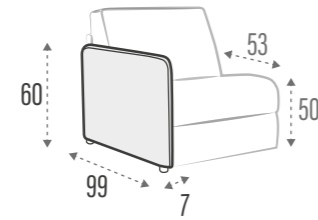

SCHIENALI | DOSSIERS | BACKRESTS

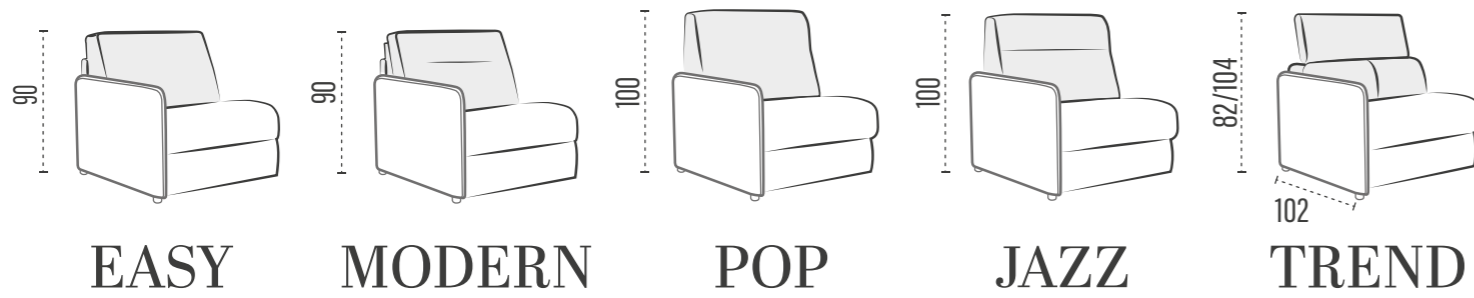

► LETTO • LIT • BED

*con materasso h. 14 cm profondità 207 cm / con materasso h. 18 cm profondità 212 cm | Profondeur totale avec matelas H14 = cm 207/avec matelas H18 = cm 212 | Overall depth with mattress H14 = cm 207/with mattress H18 = cm 212

Poltrona / Divano | Fauteuil / Canapé | Armchair / Sofa

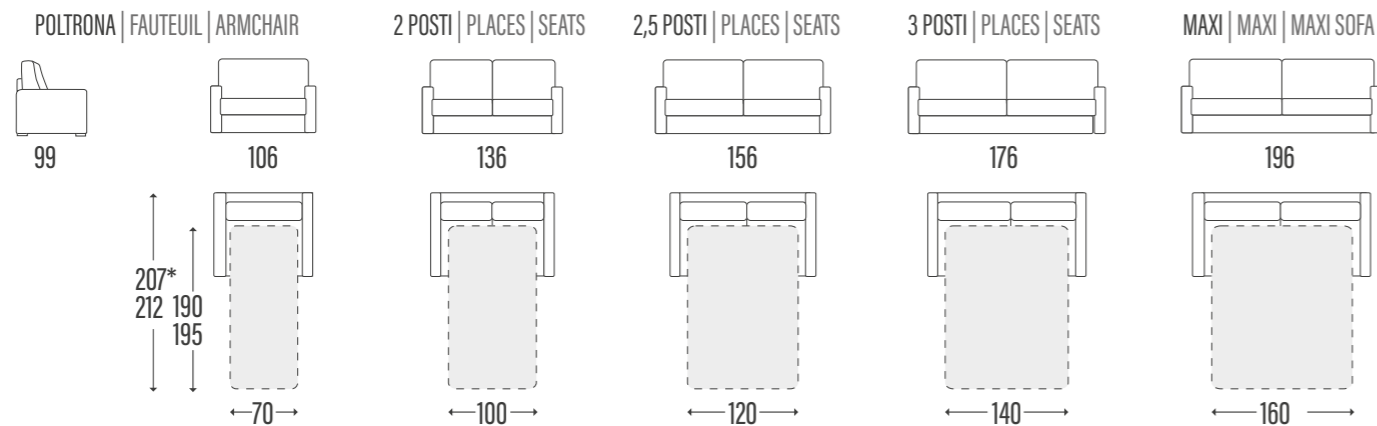

► LATERALE | TERMINAL | SIDE ELEMENT

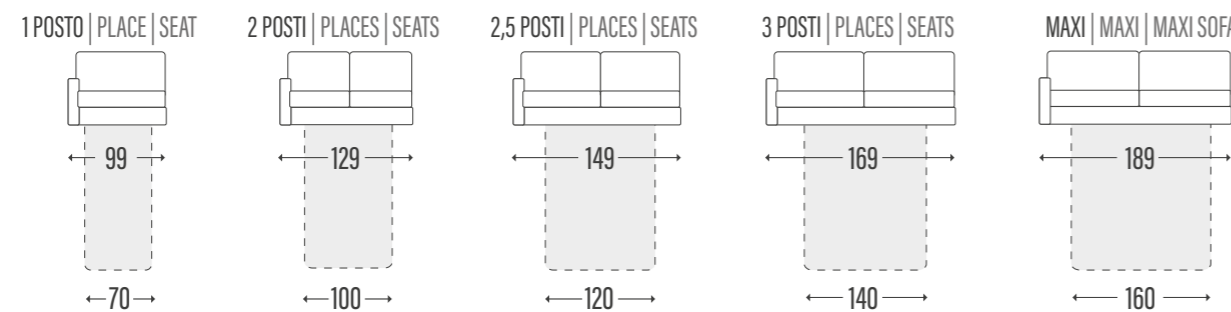

► CENTRALE | ÉLÉMENT | ELEMENT

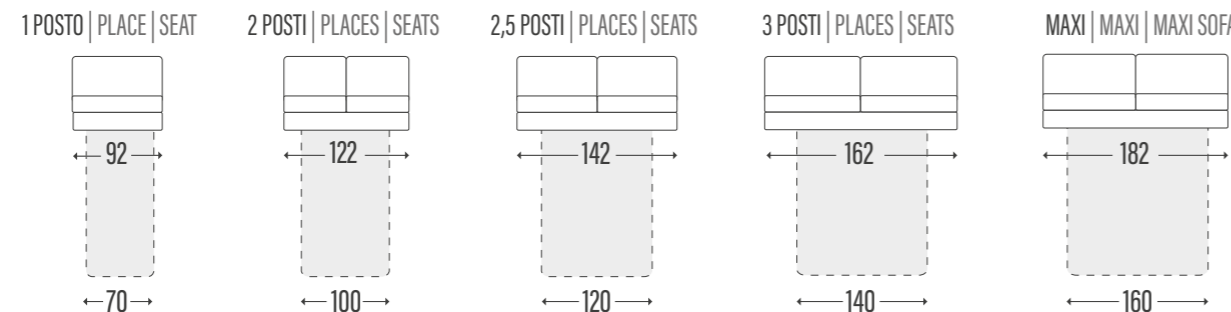

► COMPOSIZIONE | COMPOSITION

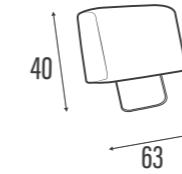
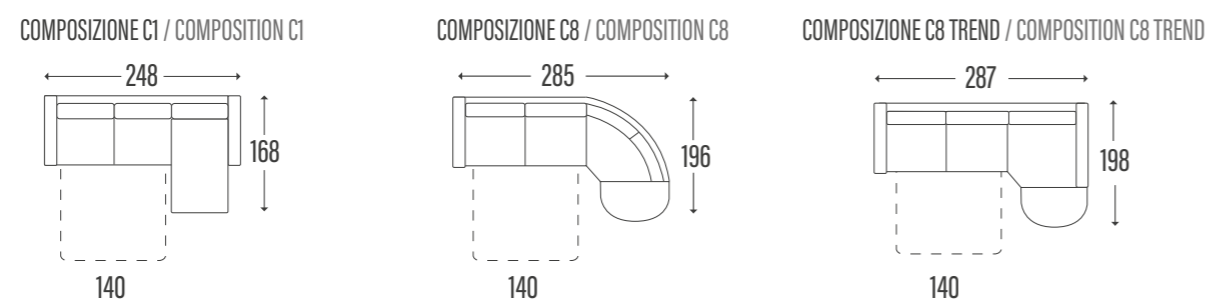

► CUSCINO SCHIENALE PER PENISOLA CONTENITORE
COUSSIN DOSSIER MERIDIENNE COFFRE
BACK-CUSHION FOR STORAGE PENINSULA

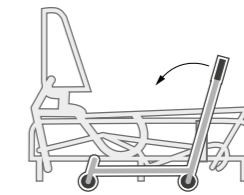

► ROLLER SYSTEM
ROLLER SYSTEM

OPTIONAL

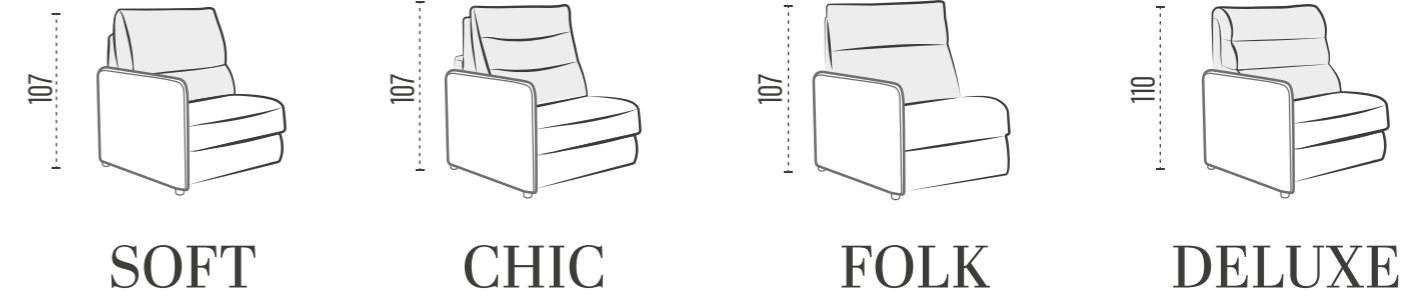

► FISSO / RELAX | FIXE / RELAX | FIXED / RELAX

Poltrona/divano | fauteuil / canapé | armchair / sofa

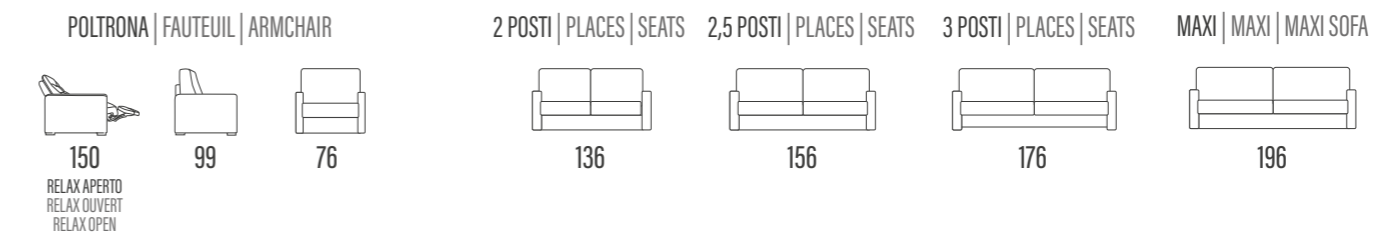

► LATERALE | TERMINAL | SIDE ELEMENT

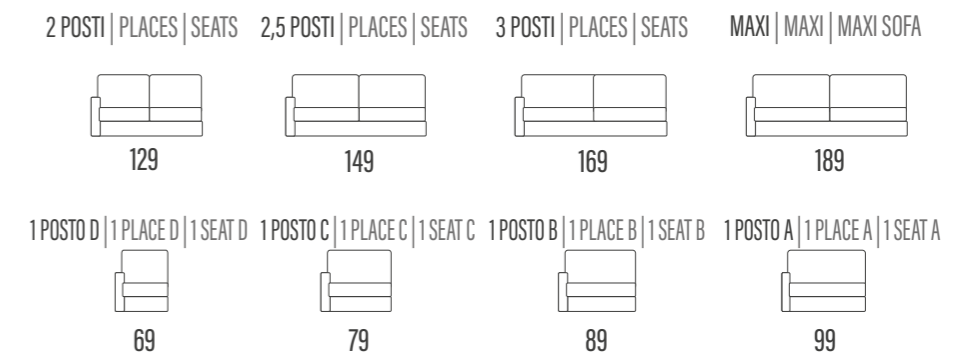

► CENTRALE | ÉLÉMENT | ELEMENT



► COMPOSIZIONE | COMPOSITION

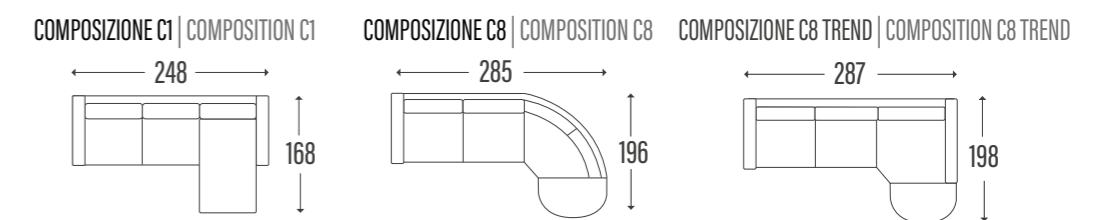

CHAISE-LONGUE CONTENITORE
CHAISE-LONGUE COFFRE
STORAGE CHAISE-LONGUE

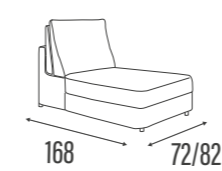

PENISOLA CONTENITORE
MERIDIENNE COFFRE
STORAGE PENINSULA

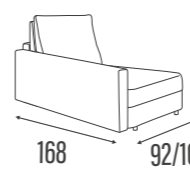

ANGOLO
ANGLE
CORNER

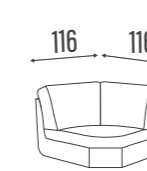

ANGOLO TREND
CORNER TREND
ANGLE TREND

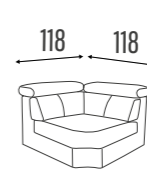

POUFF ANGOLO CONTENITORE
OTTOMAN CORNER CONTAINER
POUF ANGLE COFFRE

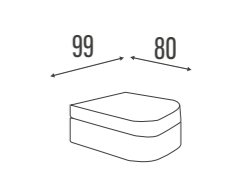

LUXURY



di Serie
STANDARD

- Disponibile H.14 lung.190cm
H.18 lung.195cm
- Poliuretano espanso DENSITA' 30 kgxm³
- Rivestimento in tessuto STRETCH all'ALOE VERA completamente sfoderabile (100% PES) trapuntato con OVATTA ACRILICA, lavabile in lavatrice a 30°
- Fascia 3D: maggiore traspirazione e maggiore resistenza a muffe e acari.
- Disponibile H.14- H.18 cm
- Polyuréthane expansé DENSITE 30 kgxm³
- Coutil en tissu STRETCH à l'ALOE VERA
- (100% PES) totalement déhoussable matelassé avec OUATE ACRYLIQUE ,lavable en machine à 30°
- Bande latérale 3D: pour une grande aération et une grande résistance contre les acariens et les moisissures
- Available H.14- H.18 cm
- Polyurethane foam DENSITY 30 kgxm³
- STRETCH fabric with ALOE VERA treatment
- Removable cover (100% PES) quilted with ACRYLIC WADDING washable at 30°
- 3D band: allows better "breathability"and therefore an improved resistance to mould and dust mites

COCCOTHERAPY



- Disponibile H.14 lung.190cm
H.18 lung.195cm
- Poliuretano espanso DENSITA' 35 kgxm³
- Strato in MEMORY FOAM H. 2 cm
- Rivestimento completamente sfoderabile, lavabile in lavatrice a 30°
- Fascia 3D e rivestimento in tessuto: Fibra naturale di COCCO
- Disponibile H.14- H.18 cm
- Polyuréthane expansé DENSITE 35 kgxm³
- Couche en MEMORY FOAM H.2 cm
- Coutil totalement déhoussable, lavable en machine à 30°
- Bande 3D et tissu du coutil en : Fibre naturelle de COCCO
- Available H.14- H.18 cm
- Polyurethane foam DENSITY 35 kgxm³
- Layer in MEMORY FOAM H.2 cm
- Removable cover , washable at 30°
- 3D band and cover in: COCCO natural fibre

NATURA

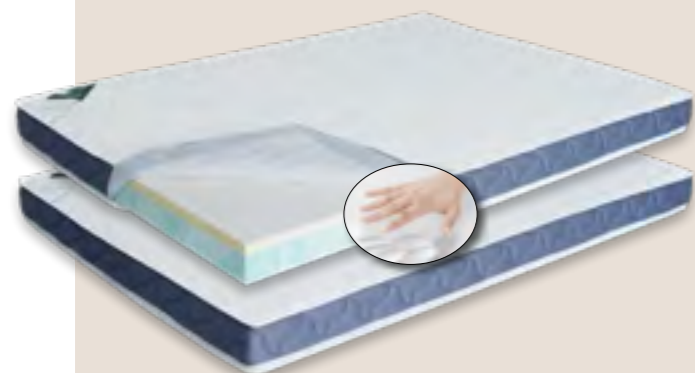

- Disponibile H.14 lung.190cm
H.18 lung.195cm
- Poliuretano espanso BIOGREEN DENSITÀ 40 kgxm³
- Strato in MEMORY FOAM H. 3 cm
- Rivestimento completamente sfoderabile, lavabile in lavatrice a 30°
- Fascia 3D e rivestimento in tessuto: all'ALOE VERA
- Disponibile H.14- H.18 cm
- Polyuréthane expansé BIOGREEN DENSITE 40 kgxm³
- Couche en MEMORY FOAM H.3 cm
- Coutil totalement déhoussable, lavable en machine à 30°
- Bande 3D et tissu du coutil à l'ALOE VERA
- Available H.14- H.18 cm
- Polyurethane BIOGREEN foam DENSITY 40 kgxm³
- Layer in MEMORY FOAM H.3 cm
- Removable cover , washable at 30°
- 3D band and cover in: ALOE VERA treatment

Rete elettrosaldata con cinghie



Sommier électro-soudé
avec sangles

Metal rigid
electro-welded grid



Rete con doghe

Sommier électro-soudé avec sangles et
grandes lattes

Metal rigid electro-welded and
wooden slats grid

